



CORVAIR FAN



CENTRAL NEW YORK CORVAIR CLUB
April 2017



IN THIS ISSUE

Page 1– Prez Sez

Page 2— Roving Reporter

Page 3 - activities

Page 4– kitchen corner
2012 club officers

Page 5— secretary’s report

Page 6– Tim’s Tech Time and
Ramblin’s

Page 7– Sponsors and ads

Page 8 & 9 — pictures & ad

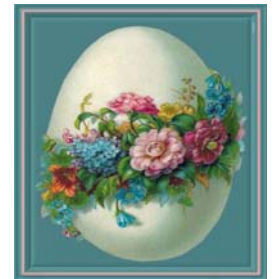

THE PREZ SEZ

Today is March 17th, St. Patrick's Day 2017. I hope we all had a happy St. Patrick's Day. I am just digging out from 34 inches of snow. I haven't seen so much snow since the Blizzard of 66. Most of the roads are plowed and most of the area is back to normal. This snow will be gone (we hope) in another 2 to 3 weeks and we can start thinking about getting our Corvairs out of moth balls.

My first car show for the year that I am planning on attending will be held in Helen, Georgia. This is a fabulous show and I have attended many of the past shows and look forward to be at this years event. The dates to remember April 28th and 29th in Helen Georgia.

Our Recall will be held in E.Syracuse NY. on June 9th and 10th. It will be at the Hilton Garden inn, so get your reservation in. The Recall will be here before you know it, hope to see you there.

We just had our annual Sunday Brunch, great food, great weather and everyone had a great time. Thank you Rita for all you have done to set up this Brunch, super job.

Well I hope I have made the dead line for this month's news letter. So till next month, stay warm, stay safe and looking forward to seeing you all at our next monthly meeting at Tabathas.
Phil CNYCC

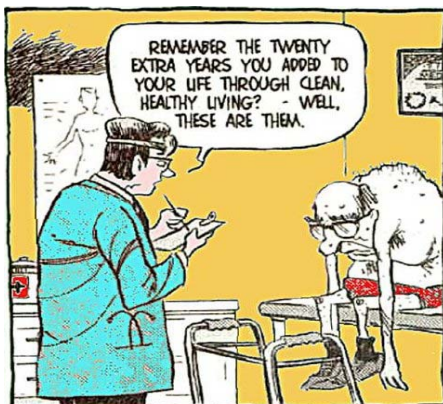

GEORGIA ROVING
by Len Smith

Since the car show and cruise-in season is not in full swing yet, I'm going to take a few month's leave to gather more auto -related news. I'll return with more exciting adventures in a few months. Stay snug and warm and count the days until Spring.

We may not be getting web site updates anytime soon — looks like our webmaster, Jim, is still digging his car out from the 3/14 blizzard. We feel your pain Jim — that was a humdinger!

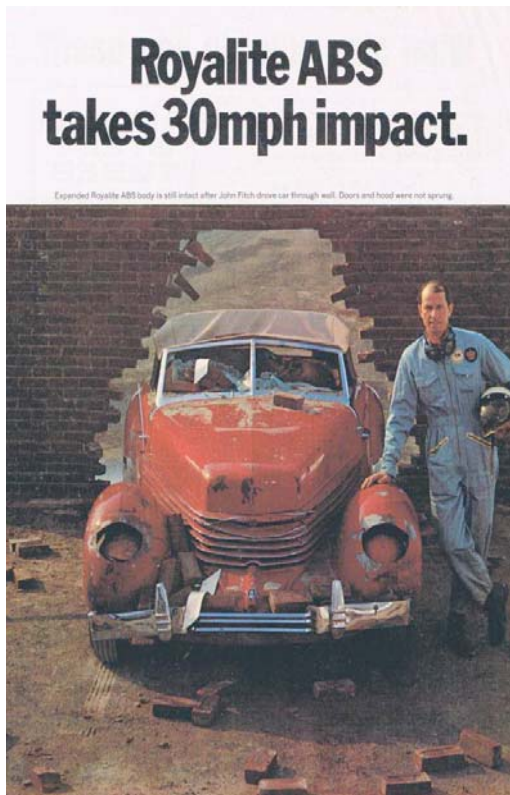

Good News!

Since so many of our group are diabetics, Tabatha has offered to make available to us a sugar free dessert on our meeting night. Don't shoot me if I'm wrong but I believe it will be a banana cream pie. Yumm-o!

Also, if you haven't noticed ——— some of the entrees can be ordered as a smaller portion with a few \$\$\$\$ off the regular price. These seem to be available on the pasta and chicken entrees. Great idea if you don't want to take left-overs home or ——— if you want to save room for dessert. Also don't forget to check the separate burger and pizza menu on the little stand on each table if you don't want a full dinner. Lots of options available to us. But whatever you decide to order ——— save room for dessert!

ACTIVITIES

Business Meetings will be held at Tabatha's, 3160 Cold Springs Rd, Baldwinsville

The meeting will start at 7:00 but our waitress is available at 5:00 so you can have something to eat before the meeting if you'd like. Meetings are in the side room, we order off her regular menu and will be given separate checks. Come early and enjoy a real home cooked meal!

April 6 — Regular business meeting — Tabatha's

April 29th — Tour of the new Antique Wireless Museum in E Bloomfield. We went to the old museum 10 years ago but they now have a new modern building all on one floor so it's easy to get around and see everything. We'll leave Arby's in Weedsport at 11:30, have the tour and end with lunch at a local restaurant.

May 4th—Regular business meeting Tabatha's

May 21st — Tour the Ag and Country Museum in Auburn and lunch at Old Erie — more info to follow for this.

June 1st — Regular business meeting Tabatha's

June 9, 10, 11 — Recall, Hilton Garden Hotel. Cruise in and valve cover races Friday evening, concours and funkanna Saturday, and farewell breakfast Sunday

June 18th — Lew's Fire Dept car show Scriba. He'll have more info on this to follow.

July 1st — Fair Haven car show 9-5, behind fire dept

July 6th — regular business meeting Tabatha's

August 3rd — Regular Business meeting Tabatha's

August 13th — VW show — not sure of this date yet since there's nothing on the net yet but if it follows past years this should be the right week for it.

September 7th — Regular business meeting Tabatha's

Sept 10th, Wampsville car show

September 17th — Jordan Fall Festival

October 5th — Regular business meeting Tabatha's

November 2nd — Regular business meeting Tabatha's

November 12th — CNYCC's annual "Corvair Family" Thanksgiving dinner at Tabatha's with all the trimmings

If you have any ideas please let us know. Everything is always subject to change. If there's subjects or projects you'd like covered at tech sessions, please let Tim know so we can plan that too. This all takes advance planning so please try to let us know early enough so we can make our events what you'd like.

Call Tim or Rita at 689-3366 or E mail Tim at N2VZD@aol.com or Rita at ritac44@aol.com



Kitchen Corner

Chicken Spaghetti Casserole with Mushrooms

- 1 lb spaghetti, cooked and drained
- 1 ½ to 2 c chopped cooked chicken
- ¼ c each chopped red and green peppers
- ½ c chopped onion
- ½ tsp salt
- 1/8 tsp pepper
- 1 (8oz) sliced fresh mushrooms
- 1 can cream of chicken mushroom soup
- ½ c chicken broth

Saute red & green peppers, onions and mushrooms. Add the rest of the ingredients; mix. Place in greased casserole. Cover and bake at 350° for 45 mins.

Apple Carrot Slaw

- ½ c sweetened dried cranberries
- ½ c orange juice, divided
- 2 granny smith apples, cored and cut into matchsticks
- ¼ c red onion, thinly sliced
- ½ c pumpkin roasted pumpkin seeds
- ¼ c chopped pecans
- 3 Tbl olive oil
- pepper to taste

Combine cranberries and ¼ c orange juice in small bowl; set aside. In separate bowl, toss apples with remaining orange juice; add carrots, onion, pumpkin seeds and pecans. Drain cranberries, reserving juice; add cranberries to apple mixture. Whisk reserved orange juice with olive oil; pour over salad. Season with pepper; toss to coat well. Serve chilled or at room temperature.

Coconut Layer Cake

- 3 large eggs
- 1 (8oz) carton sour cream
- ¾ c veg oil
- ¾ c cream of coconut
- ½ tsp vanilla extract
- 1 pkg white cake mix with pudding
- coconut cream cheese frosting

Preheat oven to 325°. Grease & flour 3 8inch cake pans. Set aside. Beat eggs. Add sour cream and next three ingredients, beating well after each addition. Add cake mix, beat until blended. Pour into pans. Bake at 325° for 25 to 27 mins or until toothpick comes out clean. Cool in pans 10 mins; remove from pans and let cook completely on wire racks. Spread frosting between layers and on top & sides of cake. Sprinkle with coconut.

2011 CNYCC OFFICERS



President
Phil Domser
315-732-1262
E-mail - pdomser1@yahoo.com



Vice President
Pete Okussick
315-252-8105
E-mail - Pokus4@msn.com



Secretary
Pam Okussick
315-252-8105
E-mail - Pokus4@msn.com



Treasurer
Kevin Fear
315-492-9553
E-mail - monza64@aol.com



Membership
Gloria Fear
315-492-9553
E-mail - globug39@aol.com



Editors/ Events
Tim and Rita Colson
315-689-3366
E-mail N2VZD@aol.com or ritac44@aol.com



Web Master
Jim Smith
pjsmith264@windstream.net

Coconut Cream Frosting

- 1 (8oz) pkg cream cheese, softened
- ½ c butter, softened
- 1 tsp vanilla extract
- 1 (16oz) pkg powdered sugar, sifted
- 1 (7oz) pkg coconut, divided

Beat cream cheese and butter until creamy; add vanilla, beating well. Gradually add sugar beating until smooth. Stir in all but ½ of coconut.

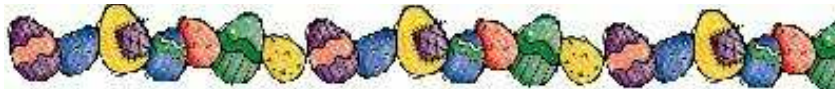

SECRETARY'S REPORT

March 2nd, 2017

President Phi Domser called the meeting to order at 6.55.

Secretary's report- Motion made by Lew and seconded by Corina to dispense with the reading of the minutes. Motion approved.

Treasures report- Kevin states the balance for the checking account, Kevin also states a check was written for postage in the amount of \$32.55 and a deposit in the amount of \$40.00 and a deposit in the amount of \$65.00 was made into the account, then a motion to approve the final amount was made by Michelle and seconded by Corina. Motion approved.

Old Business- Recall- We will stuff the door prize bags at next month's meeting.

Dave asked that everyone please continue to look for items for door prizes and bring them to next month's meeting.

We make the most money on advertisements in the booklet so please everyone work on getting more advertisements in the booklet.

Vendors are Welcome to set up tent's outside for a fee of \$5.00 a tent. In the Fast Track lot.

New Business-

Dues are due next month April 1st \$25.00.

Any questions on Recall feel free to contact Pam O'Kussick 315-252-8105 or Dave Robinson 315-656-9639.

Don't forget Sunday March 5th, 2017 at 11:00 is the Brunch at Orchard Valley if you have not contacted Rita for reservations you need to call her ASAP.

50/50 Drawing winner was Michelle in the amount of \$22.00.

Motion to adjourn the meeting was made by Tim and seconded by Lew and the meeting was adjourned at 7:13.

Respectfully Submitted.

Pam O'Kussick
Secretary

Those attending the March meeting Dave Robinson & Marge, Tim & Rita Colson, Lew, & Clara Halstead, Skylar, Michele, & Shelby Davis, Kevin & Gloria Fear, Lee Evans, Corina Edwards, Phil & Martha Domser, Brandon & Lori Connors, Pete & Pam O'Kussick.

TIM'S TECH TIME AND RAMBLIN'S

HELLO AGAIN from the little Corvair Shop in Memphis NY.

I am having a lot of "fun?" in the shop The further I get into this year , the more "conflicts" I run into in upcoming months. One weekend in September has 3 choices , and I like all of them. It will be a tough call on at least 3 of the weekends. So it will be another "exciting" year here.

I have been getting updates from the body shop that is doing the White and Red Rampside belonging to Judy and Dan Burrows. It is coming along nicely , and as I predicted , it has been lots more work than planned. It has been changed to the colors that the body number plate indicates. By visiting that shop , I learned more about modern body repair methods and materials.

This winter has been rather tough at times , so I am running behind . The "Cord project" is a real time soaker , and not having any shop manual to work with , slows some of the work down. The wire harness comes coiled up in a box with no connector housings , just bare terminals and plugs. Sorting it out , and getting it in the correct place , and hooking up all the gauges and switches will not be easy. Getting the old 4 speed shifter removed was not easy either. Then I have to design a dash sub panel sturdy enough to support a powerglide shifter yet. This car will be really interesting to drive when we get done with it.

On my own vehicles , I have a lot to do as soon as I can make room in the front part of my shop. I ended up having to store a lot of extra things this winter , which cramped my plans a lot. It will not happen again.

There are going to be a lot of nice shows coming up , so soon I will be trying to get all the information together so we can plan events. We know Fairhaven is the 4th of July weekend , and Waterloo is the Memorial day (28th) weekend. We also know that Rita and I will not be here for Jordan Fall Festival this year. It is the weekend of the Baystate Clark's Corvair show. It would be too wild of a ride to make it home in time to participate there. I think at least 3 couples from here will be at Clarks. So some one else will have to get to Jordan EARLY to hold that super spot. Even when we get there at @8AM , there are people eying that area. The same goes for most shows now , they do not "save spots". Only one that does is the VW show.

We are trying to fit in a couple of very nice group tours this year also. So be ready for more fun times with our cars. I would like to see more people getting CB's OR , if a Ham , bring a radio , so trips will go smoother. After all of our years traveling all over VT keeping a LOT of cars together , I miss that type of organization here. It takes very little practice to maintain a proper distance between cars at all times , especially when in areas we have to deal with Stops and turns. It is important to try to keep together , and a good eye on the car BEHIND you. We also try to park all the Corvairs together whenever we stop , so picture taking can happen. We try to group them in front of the building or sign of that stop. Makes nice pictures for newsletters etc. I hope we have another successful Recall to continue the legacy started by our founders We hope to see you all at our next meeting. Regards , from Tim Colson http://cnycorvair.com/Little_Corvair_Shop **THINK RECALL!**

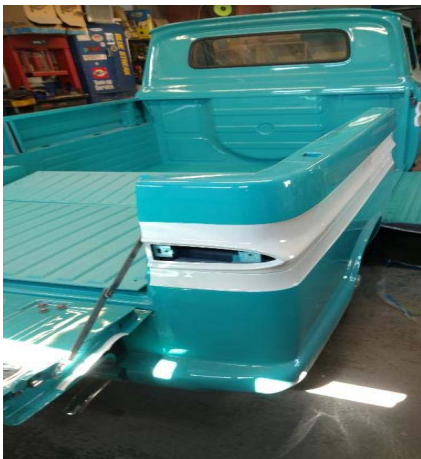

Judy and Dan Burrows 63 Rampside at the body shop in Clark's Mills NY
This used to red and white

WE WISH TO THANK ALL THE SPONSORS AND SUPPORTERS OF OUR CLUB AND THE RECALL. WITHOUT THE HELP THEY PROVIDE WE COULD NOT DO IT , PLUS THE WORDS " CORVAIR PARTS AND SERVICES" WOULD BE HISTORY..

America's Oldest Corvair Shop

- Top Quality Restorations
- Over 45 Years of Corvair Experience
- From Tune-ups to Engine Overhauls
- Transmission & Differential Rebuilds
- Suspension & Brake Overhauls
- Interior & Exterior Restoration
- Economical Transport Service
- Free Estimates
- Payment Plans

Bill, Kathy & Tim Cotrofeld
Shop: Rte. 7a
PO BOX 235
E. Arlington, VT 05252

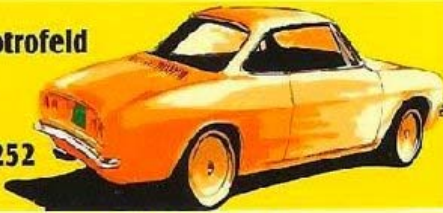

phone: 802-375-6782
fax: 802-375-0052
email: cotrofeldauto@comcast.net



635-5681 7AM —7PM
 MONDAY - FRIDAY

Clark's
Corvair Parts®



DAVE'S AUTO SERVICE
 "Complete Collision Service"

Days:
 607-898-5240

Nights:

Paul 607-838-8222 - Dave 607-898-9586

Route 222 - Groton, NY 13073

This will be **THE Catalog** until 2013

Includes → All our **NEW** parts, **KITS**, many improvements and updates.

Over 6 solid months in the making!
 updates on 80% of pgs!

Over
 670 pages
 1900 photos
 1100 sketches

Over
 500 exploded diagrams
 15,000 parts listed
 11,000 index entries

M - O - R - E
 Clark Multi Kit choices

You need THIS Catalog!

► **HOW TO GET ONE?**
Rush Order - JUST THE CATALOG order over the internet or by any of our regular methods
 \$6.00 USA, \$8.00 Canada Foreign contact us

WITH a PARTS ORDER -
 order CAT-O \$4.00 3 Lbs.

Clark's Corvair Parts,® Inc.
 400 Mohawk Trail, Shelburne Falls, Ma. 01370
 413-625-9776 www.corvair.com

Thicker than ever!

PLUS MANY OTHERS.....THANKS TO ALL OF YOU!!

I FOUND THESE PICTURES ON THE CORVAIR FORUM WEBSITE
more pictures of rare Corvaair based things from the past. This one is a one only and was very early
(around 1960) "Called "Jeepvaair"

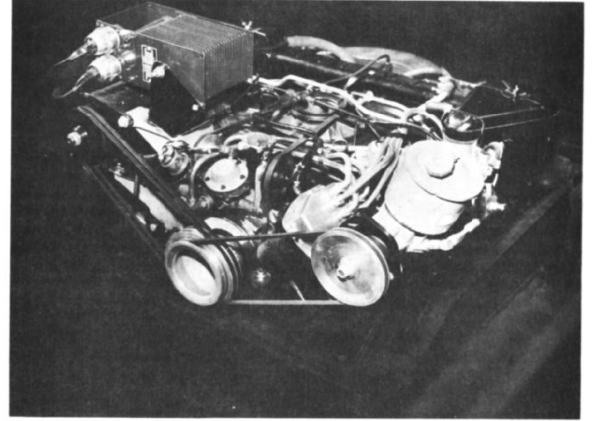

Powered by early Corvaair.

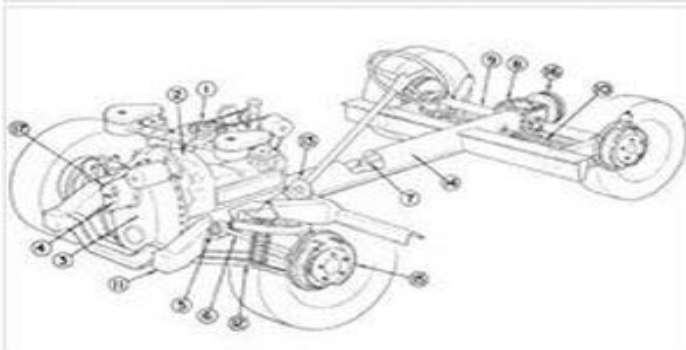

Peter Fredsall ▶ **Corvaair**
March 21 at 5:17am

The Truck Utility Floatable Independent is an Amphibious Corvaair-powered truck commissioned by the military in the early '60s. One TUF was built and tested.

CENTRAL NY CORVAIR CLUB INC
PO BOX 616
JAMESVILLE, NY 13078



www.cnycorvairst.com

C.N.Y.C.C. MEMBERSHIP

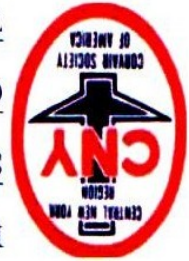

NAME: _____

STREET ADDRESS: _____

CITY: _____ STATE: _____ ZIP: _____

TELEPHONE: _____ E-MAIL: _____



ARE YOU A MEMBER OF CORSA? _____
HOW MANY CORVAIRS TO YOU OWN? _____ PARTS? Y ___ N ___
PLEASE JOIN NOW! Ask us for details

CENTRAL NEW YORK CORVAIR CLUB WELCOMES YOU.
PLEASE FEEL FREE TO ADD ANY COMMENTS TO THIS FORM.

Please remit form and dues (\$25.00) to:

Central New York Corvairst Club
Gloria Fear
P.O. Box 616
Jamesville, NY 13078



JOIN US
Corvairst Fans come join the Central New York
Corvairst Club. We are a fun group! We have
an outing every month and a business
meeting once a month. We have tech sessions
every once in a while. We would like new
members and new ideas. We are a very social
group and wives are always invited. For more
information please call Kevin or Gloria Fear
at 315-492-9553. We hope to see you at the
next meeting.

The Central New York Covair Club
Presents the 42nd Annual

Corvair Recall

June 9th, 10th, and 11th 2017



Friday June 9th
Cruze-in
Valve Cover Races

Saturday June 10th
Concours and Car Display
Funkhanna Racing
Awards Banquet featuring Domicolo-Barlow Band

Sunday June 11th
Farewell Breakfast

Events Located Across from the Hilton
Garden Inn
6004 Fairlakes Rd, E. Syracuse, NY 13057

For more information contact
Dave at 315-656-9639
(kb2hba@twcny.rr.com or
Pam at 315-252-8105
(pokus4@msn.com)



PLAN NOW ON ATTENDING !!